



AERIS WINDOWS
& PATIO DOORS



AERIS™ WINDOWS & PATIO DOORS



SHOWN ON THE COVER

Aeris™ Casement, Awning and Shaped windows with Cherry Wood stained Hazelnut with Antique Brass Hardware

SHOWN ON THIS PAGE

Cherry Wood stained Hazelnut Aeris 3-Lite Sliding Patio Door with Antique Brass Hardware

Table of Contents

A Message from the CEO	02	Understanding the NFRC Label.....	17
ENERGY STAR®	03	Privacy and Tint.....	18
Why Choose Wood-Clad Vinyl.....	04	Grids.....	19
Window Features	06	Internal Blinds	20
Patio Door Features.....	08	Decorative Glass	22
Window and Patio Door Types	10	Art Glass.....	23
Paint and Stain Colors.....	12	MasterFit™ Trim.....	24
Hardware.....	14	Warranty Highlights.....	26
Glass Packages.....	16	Discover More.....	28



THE PROFESSIONAL WAY

ProVia® caters to a niche within the window and door market that demands a high degree of customization coupled with outstanding quality. Our company defines the products that meet this demand as “professional-class.” We have found success by adhering to a set of core values that guide us as we develop rewarding, long-term relationships with our employees, customers and homeowners.



**Our Mission: To Serve, By Caring
for Details In Ways Others Won't**



**DOORS | WINDOWS
SIDING | STONE | ROOFING**



Doing Business Since 1977



1,900+ Associates Nationwide



**Multi-Time ENERGY STAR®
Partner of the Year Award Winner**



**90%+ Windows & Doors are
ENERGY STAR® Certified**



**2,100,000 sq. ft Total
Manufacturing / Warehouse Space**



**8,500 Tons of Metals, Paper,
Glass and Vinyl (Window and
Siding) Recycled Annually**

INDUSTRY ASSOCIATION

ProVia is a proud member of the Window and Door Manufacturers Association (WDMA) and American Architectural Manufacturers Association (AAMA) - leading voices in our industry. As such, we support advocacy in building code and ASTM standard arenas, quality materials, installation and design in Doors and Windows.



ACCREDITATION AND TESTING

ProVia's products are voluntarily third party tested and rated in several energy performance categories through the National Fenestration Rating Council and meet or exceed standards governed by the American Architectural Manufacturers Association.





Dear Homeowner

At ProVia® we consistently raise the bar in our engineering and manufacturing processes to bring top-performing products to market, as evidenced by this, our 15th ENERGY STAR® award. We're honored to help American families and businesses save energy and money every day. ProVia prioritizes energy efficiency education as well, through dealer/distributor training and marketing materials.

At ProVia, we truly care about our customers and our products. Every employee is committed to providing you with an exceptional experience, and we take seriously the trust that homeowners place in us to design and craft building products that excel in durability, energy efficiency, security, and long-lasting beauty.

Brian Miller, President & CEO



ENERGY STAR®

WE'RE COMMITTED TO ENVIRONMENTAL STEWARDSHIP

When you purchase energy-efficient doors or windows from ProVia, you're doing more than conserving energy in your own home. You're supporting our company's commitment to protecting the environment that we all call home.

ENERGY EFFICIENCY & SUSTAINABILITY

We are committed to exercising corporate environmental stewardship because it aligns with our Core Values of Integrity, Continuous Improvement and Sustainability. Every day, we strive to do our part to protect our natural resources by recycling, reusing materials where appropriate, and reducing pollution emissions.



In 2021, we completed installation of a 1.792 MW solar array at our stone manufacturing facility, comprised of 4,480 solar panels. It is expected to reduce electrical power consumption by 60% and to prevent emission of 1,472 tons of CO2 annually.

Sustainable product development is important to ProVia—in addition to the solar array, our stone manufacturing plant employs rainwater holding tanks and uses recycled water on the production line, our residential metal shake and slate roofs are manufactured from domestically sourced recycled steel, and our siding products contribute to LEED and ICC 700 National Green Building standards.

ENERGY PERFORMANCE CALCULATOR



ENERGY STAR and the EPA are committed to improving manufacturer's products to ensure energy efficient products are being produced.

ProVia is committed to helping you find energy-efficient doors and windows that meet ENERGY STAR requirements.

Follow the QR Code to find the NFRC ratings and ENERGY STAR qualifications of a window or patio door.

Why Choose

WOOD-CLAD VINYL?

YOUR VERSATILE WINDOW SOLUTION

Add warmth to the interior of your home with wood. Aeris™ windows and patio doors are wood-clad, allowing you to choose between several factory-finished paint and stain colors to complement your homes' unique style.

The exterior of Aeris windows and patio doors are constructed of a uniquely formulated, proprietary vinyl compound proven to perform better than alternative building materials. Vinyl ensures long-lasting color-retention and low maintenance, plus the added confidence of a warranty against rotting, cracking, pitting, corroding and peeling. The vinyl is resistant to rot, insect and microbial damage, never requires painting and is easy to clean.



LOW MAINTENANCE

Vinyl is the low-maintenance choice for residential use.



SUPERIOR WEATHERABILITY

The vinyl compound is uniquely formulated to withstand the harsh effects of weather, UV light and southern exposure.



COLOR RETENTION

Pharmaceutical-grade compounding and blending systems provide consistency, so you can rely on superior color and weatherability.



DESIGNED TO PERFORM

Industry partnerships and on-going research into new technologies ensure the vinyl compound exceeds industry standards, outperforms the competition, and works together to offer best-in-class technology.

Choosing both wood and vinyl for your window and patio door is a win-win – you get the beauty of wood inside, plus low-maintenance vinyl outside.





Cherry Wood stained Hazelnut Aeris
Casement windows with Antique
Brass Hardware

WINDOW FEATURES

Aeris™ windows can be completely customized to fit your exact style. Everything from the size of the window, the interior and exterior colors, hardware finishes, glass packages and trim options can be chosen by you.



The Components



REAL WOOD INTERIOR
Aeris windows feature factory-finished Oak, Cherry or Maple wood applied to the sash and frame interior.



FRAME
Aeris windows are constructed with a 3/4" vinyl frame. Both the sash and frame are welded for increased strength.

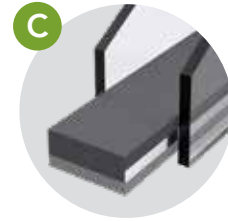

GLASS PACKAGE
Aeris windows feature a 1" ComforTech™ Insulated Glass Unit. A DLA-UV glass package is standard. See page 16 for other options.



INSULATION
A graphite foam insulation is added to the frame, providing greater energy efficiency and performance.



BARRIER-FIN WEATHERSTRIPPING
This weatherstripping provides a barrier against air, water, dust and noise.



BULB SEAL WEATHERSTRIPPING
This weatherstripping prevents water from penetrating the foam cell structure and has a unique UV-resistant barrier.



EXTRUDED ALUMINUM SCREEN FRAME
A rigid and durable frame that holds the screen mesh in place and is easy to remove for cleaning and maintenance.



BETTERVUE® FIBERGLASS MESH
This mesh is very durable and flame retardant, providing an enhanced view, increased insect protection and improved airflow.



FLEXSCREEN®
A great alternative screen frame option that is easy to install. It perfectly hides within the window frame, drastically improving sight lines. This is standard on painted exterior windows.



PROFILE™ DA LOCKS*
"DA" stands for "Dual Action" - it locks and tilts the window, all in one motion.



WOOD LIFT AT LOCK RAIL*
This feature makes it easy to lift the bottom sash of a Double Hung window up with ease.



BALANCE SYSTEM*
The block and tackle balance system allows the top and bottom sashes on a Double Hung window to effortlessly slide up and down.

* Applies to Double Hung Windows.

PATIO DOOR FEATURES

Aeris™ patio doors can be completely customized to fit your home. Everything from the size of the door, the interior and exterior colors, hardware finishes, glass packages and other glass options can be chosen by you.



The Components



REAL WOOD INTERIOR
Aeris patio doors feature factory-finished Oak, Cherry or Maple wood applied to the sash and frame interior.

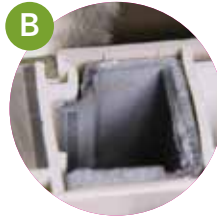

REINFORCEMENT
Galvanized steel reinforces the panels and sill to ensure rigidity and stable operation.



PATENTED WATER DRAINAGE SYSTEM
This allows water on the sill to drain to the exterior of the home.



INSULATION
A graphite foam insulation is added to the frame, providing greater energy-efficiency and performance.



SLIDING SYSTEM
A patented sliding system, featuring four adjustable 1" wheels per operating panel, allows the sash to glide effortlessly on the sill.



ACCUVENT™
ProVia's® proprietary design featuring a sash lever combined with a top-mounted ratchet and lock system allowing multiple venting locations and peace of mind.



ALUMINUM SCREEN FRAME
A rigid and durable frame that holds the screen mesh in place and is easy to slide within the screen track.



SCREEN LATCH
A spring-loaded screen latch system automatically engages upon closing.



BETTERVUE® FIBERGLASS MESH
This mesh is very durable and flame retardant, providing an enhanced view, increased insect protection and improved airflow.



BARRIER-FIN WEATHERSTRIPPING
This weatherstripping provides a barrier against air, water, dust and noise.



BULB SEAL WEATHERSTRIPPING
This weatherstripping prevents water from penetrating the foam cell structure and has a unique UV-resistant barrier.

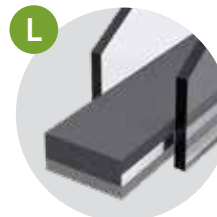

GLASS PACKAGE
Aeris patio doors feature a 1" ComforTech™ Insulated Glass Unit. A DLA-UV glass package is standard. See page 16 for other options.

TYPES

Windows

Double Hung

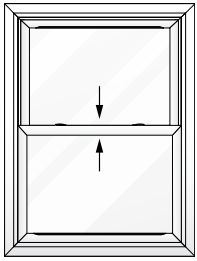

Slider

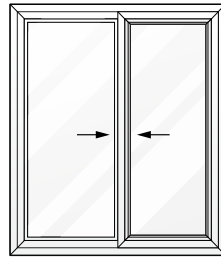

Picture

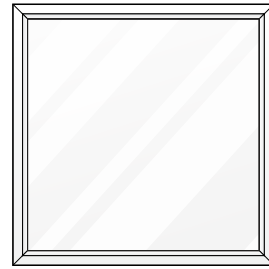

Casement and Awning

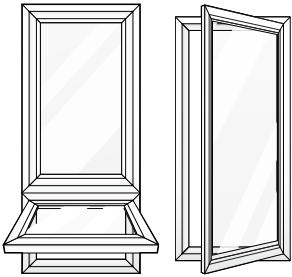

Bay and Bow

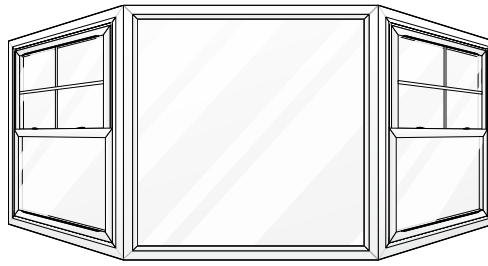

Architectural Shapes

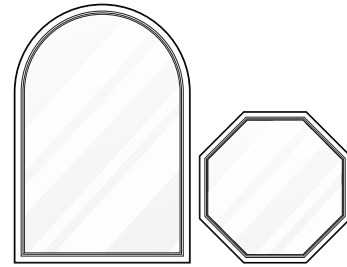

Patio Doors

2-Lite

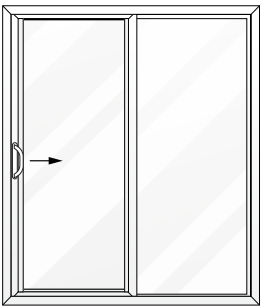

3-Lite

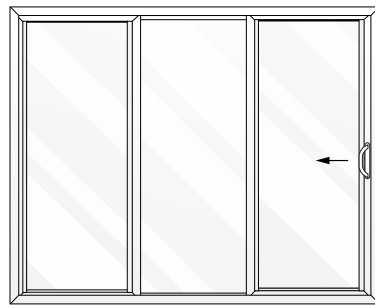

4-Lite

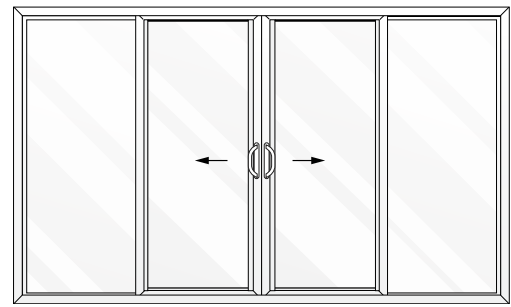

Fixed Sidelites



Transoms





Aeris™ Double Hung windows painted Snow Mist White with Flat Bronze Hardware and custom SDL grids

COLORS

Interior Stain Finishes

Oak

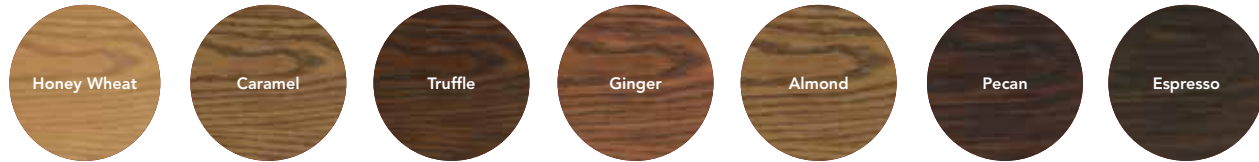

Cherry



Maple



Interior and Exterior Paint Finishes

Maple



Trending paint colors also available. See entryLINK for all color options.

Exterior Vinyl and Tuffex Smooth Cladding* Colors

*Aluminum trim coil with mar-resistant smooth finish



*Classic Bronze is a laminated option on vinyl.

Always refer to our color selector for accurate color representation.
Jamb pocket color may be different than the interior paint or stain color.

Custom-Matched Paint Colors

How to Order Custom Painted Windows and Patio Doors

1. Visit a Sherwin Williams paint store and select a paint color of your choice.
2. Specify the selected color name and paint number from the paint color swatch at the time of order.

OR

1. Provide your dealer with a 3" x 3" sample of the selected color for ProVia® to match.



Sandstone 3-Lite Sliding Patio Door with Sandstone Hardware



Aged Bronze Signature Hardware with Keylock

HARDWARE

Windows

Double Hung and Slider



Profile™ DA Lock

Casement and Awning



Lock Out Crank Handle

The lock-out feature prevents the handle from closing prematurely while operating the window. The handle can be easily put in the closed position by engaging the lever on the back.

Patio Doors

Signature Hardware

available with and without keylock



Modern Hardware

with Keylock



Window and Patio Door Hardware Colors

Standard Finishes

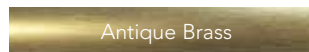

Antique Brass



Bright Brass+

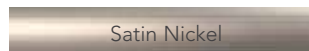

Satin Nickel

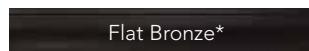

Flat Bronze*

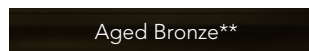

Aged Bronze**

Optional Finishes



White



Beige



Sandstone



Black***

+ Bright Brass not available on Casement and Awning windows.

* Flat Bronze is for windows and is not an exact match to Aged Bronze.

** Aged Bronze is for patio doors and is not an exact match to Flat Bronze.

*** Black is available for patio doors only.

Modern patio door hardware available in Aged Bronze and Satin Nickel.



Antique Brass Casement Hardware

GLASS PACKAGES

Featuring Comfortech™ Warm Edge Glazing System

Aeris™ windows and patio doors are primarily made up of glass. That's why we use the Comfortech Warm Edge Glazing System featuring Super Spacer® on all Aeris products. This gives you reduced heat loss, warmer glass temperature and reduced interior condensation. All Comfortech products have passed stringent testing and are IG Certified to ensure seals are durable and will not leak.

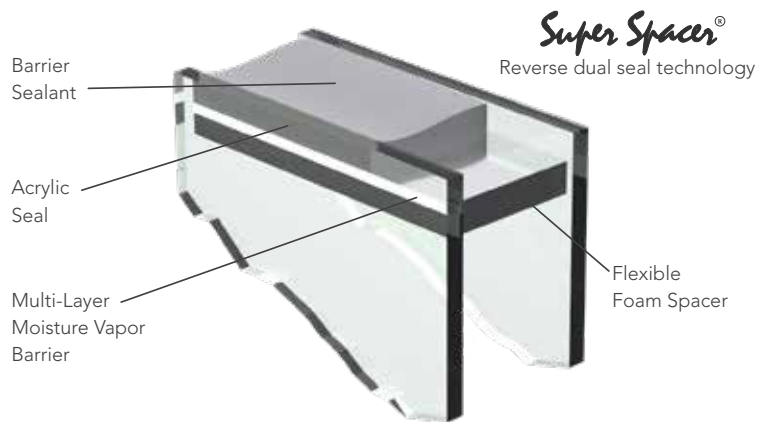

The No-Metal Advantage

Thermal efficiency through no presence of conductive metals.

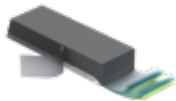

Mylar 10-Layer Vapor Barrier

Moisture is kept out, gas is kept in and conductivity is virtually nonexistent.



Lasting Appearance

Stands up to the natural bending and bowing from temperature changes, barometric pressure and wind load.



Enhanced Noise Reduction

Excellent sound dampening properties reduce outside noise, even in industrial environments.

WHAT'S THE DIFFERENCE?

Krypton Gas

Inert to glass coatings, heat and spacers, krypton gas has the lowest conductivity of any gas used and raises the inner glazing temperature. This gas performs well in small chambers, making it the best choice for triple-glazed glass packages.

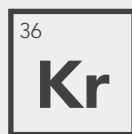

Argon Gas

Chemically inert to UV radiation, argon gas insulates better than air. It is sunlight stable, non-corrosive and non-toxic, making it the best choice for double-glazed glass packages.

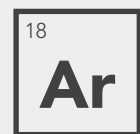

Standard for Aeris

Comfortech™ TLA-UV

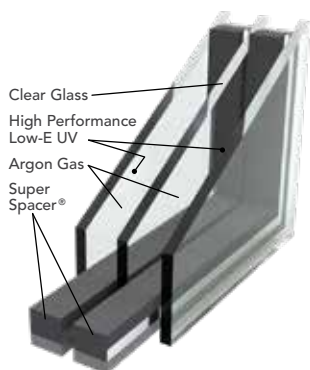

Comfortech™ DLA-UV-HC



Comfortech™ DLA-UV

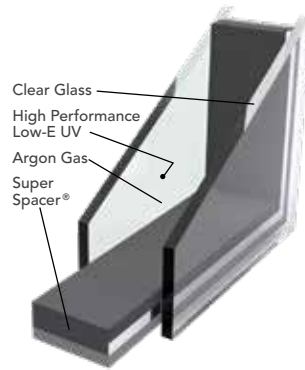

Comfortech™ DLA

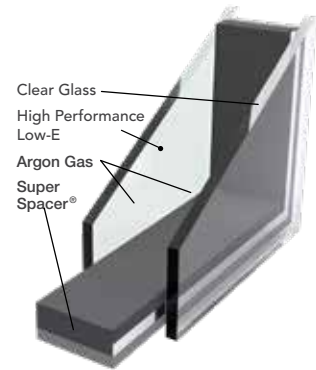

Several other double and triple glazed glass packages are available, including with Krypton Gas (triple glazed only) as well as Hard Coat and Low-E options.

R-Value reflects center of glass data only. Actual values will vary based on the window package chosen.

UNDERSTANDING THE NFRC LABEL

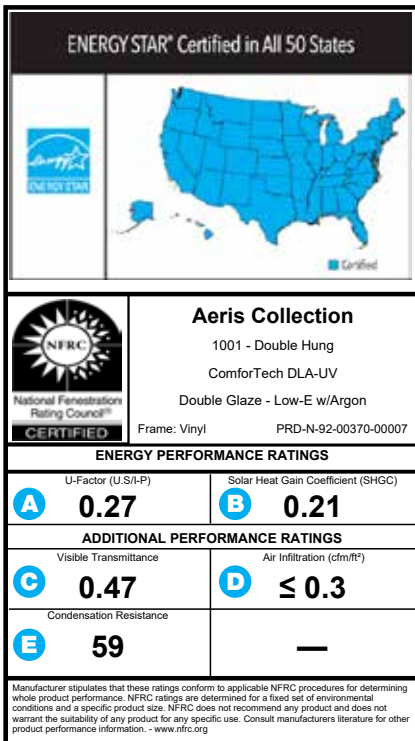

For example purposes only. Numbers will vary based on the window or patio door package chosen.

- A U-Factor** – Insulating value of the entire window system. Lower numbers reflect better insulating value.
- B Solar Heat Gain Coefficient (SHGC)** – Amount of heat from the sun passing through the glass. Lower numbers indicate glass is keeping heat from entering your home. SHGC is measured on a scale from 0 to 1.
- C Visible Transmittance** – Amount of visible light passing through the glass. Higher numbers indicate glass is allowing more light to enter your home. Visible transmittance is measured on a scale from 0 to 1.
- D Air Infiltration** – How much air is entering or escaping through the window. Lower numbers indicate air is kept from entering or escaping.
- E Condensation Resistance** – Amount of moisture it takes for glass to condensate when exposed to extreme interior and exterior temperature changes. Higher numbers indicate better resistance to condensation. Condensation resistance is scored on a scale of 0 to 100.

ENERGY STAR®

There are some important things to note about what makes a window or patio door ENERGY STAR certified.

ENERGY STAR certified windows and doors:

1. Are manufactured by an ENERGY STAR partner
2. Are independently tested, certified and verified by the National Fenestration Rating Council (NFRC)
3. Have NFRC ratings that meet voluntary energy efficiency guidelines set by the U.S. Environmental Protection Agency (EPA)

Though ENERGY STAR does not require any specific technologies, certain product features are common in many certified products.

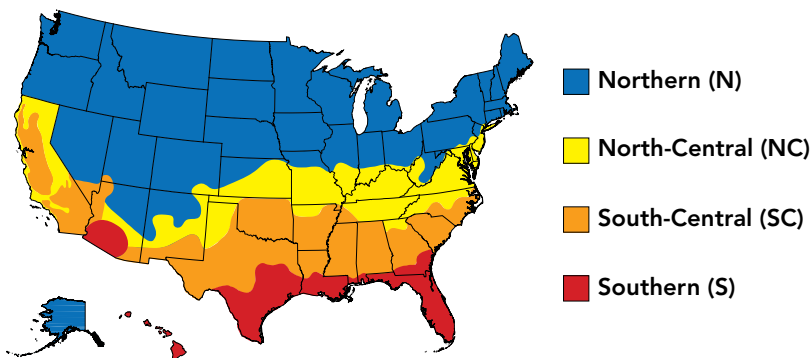

ENERGY STAR REQUIREMENTS

WINDOWS			
Climate Zone	U-Factor	SHGC	
Northern	≤ 0.27	Any	Prescriptive
	≥ 0.28	≥ 0.32	Equivalent Energy Performance
	≥ 0.29	≥ 0.37	
	≥ 0.30	≥ 0.42	
North Central	≤ 0.30	≤ 0.40	
South Central	≤ 0.30	≤ 0.25	
Southern	≤ 0.40	≤ 0.25	

Information on pages 16 & 17 is accurate as of December 2022. Visit provia.com to view the most up to date version of this brochure.

PRIVACY AND TINT

Privacy Options

Choose from five different types of glass if you need light to filter in, yet want to maintain privacy. These glass styles look great in rooms where privacy is important.



Chinchilla



Taffeta



Waterfall



Gluechip



Obscure Pebble

Actual privacy levels will vary depending on your distance from the glass and also the amount of light in the room in comparison to the light outside your home. For extra privacy, contact customer service to add an extra pane of privacy glass to your window or patio door order.

Tint Options

Tinted glass can help reduce UV transmittance, solar heat gain and glare. Tinted glass options can give a room a whole new look, providing its own unique set of benefits. Be sure to choose the right one for your home.



Clear Glass



Bronze

High visible light transmittance
Warm glow to interior décors
Complements brick and stone
Ultraviolet light protection



Green

Subdues interior brightness
High visible light transmittance



Gray

Excellent glare control
Exceptional protection against interior fabric and color fading
Ultraviolet light protection



Blue

Low shading coefficient
High visible light transmittance
Solar performance (reduces solar heat gain)

GRIDS

The style of grids you choose can make a big impact on your home's appearance. Grids look great on the front side of a house or in accent windows throughout the home. You can choose from internal or external grids and several grid patterns including variations of Colonial, Cottage and Prairie styles.

External Grids (Simulated Divided Lites)

Grids are applied to the glass on both the interior and exterior of the window or patio door. If you decide to get the exterior painted, choosing SDL's as your grid choice allows the SDL's to be painted to match your interior and exterior color.



Internal Grids

If you want grids, but prefer not to clean around them, opt for internal grids so you get the same look without the hassle.



Contoured



Flat



Pencil

Available in Satin Nickel, Brass and Bronze (for windows only)



V-Groove
Available in 3/8"

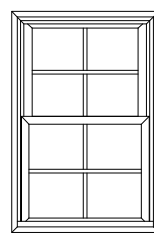

Cottage

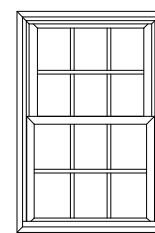

Colonial

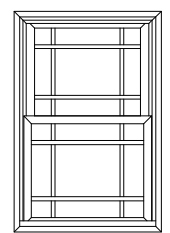

Prairie



Cottage



Colonial



Prairie

INTERNAL BLINDS

Internal blinds are a convenient option for blocking harsh sunlight and increasing privacy on patio doors and windows.

Constructed with sturdy aluminum and enclosed in tempered safety glass, the blinds are protected from weathering, damage, and dust, and they are not a hindrance to cleaning your glass.



2-Lite Sliding Patio Door painted Coal Black with White Internal Blinds and Satin Nickel Hardware

Blind slats are ½" wide.

*Internal Blinds come with a **10-year Limited Warranty.***

Allow for additional lead time on your window and patio door order.

Blinds and grids not available together.

Not available in 50" x 80" or 96" x 80" patio door sizes.

Available Colors

Internal blinds are available in white plus four neutral hues to complement any room in the house.



White



Cream



Tan



Silver



Champagne

Blind Operators

Blind operator as viewed from the interior of your home.



Blink® Blinds

White internal blind operator for patio doors



Internal blind operator for windows and all colored blinds

DECORATIVE GLASS

Decorative glass available for windows only.

Decorative glass is unique in that it achieves its personality and beauty through aesthetic imperfections – waves, striations, and air bubbles that create natural effects and singular characteristics. ProVia® decorative glass mimics the hand-made sheet glass of centuries past, and these stunning ornamental designs elevate the look of your windows, boosting the curb appeal of your home.



ProVia Exclusive

These decorative glass designs are only found on ProVia products. This gives your home a unique style that can't be found anywhere else.



Covered by a Lifetime Limited Warranty

Warranty includes glass breakage and seal failure.



Laurence
Decorative Glass



Esmond
Decorative Glass



Cheyenne
Decorative Glass

ART GLASS

A ProVia® exclusive, Art Glass offers you an opportunity to create a unique artistic statement using design and color. Your window and patio door glass can reflect the inspiration of your creative vision and allow you to display an original piece of art with beautiful curb appeal.

An assortment of exquisite classic and contemporary ornamental patterns are available. Choose from a diverse collection of Art Glass designs – some patterned from styles in our Decorative Glass collection – and fill with your choice of color. Or create a custom, personalized design of your own.



View All
Decorative and Art
Glass Options in
the Glass Brochure



Esmond
Art Glass



Americana
Art Glass



Blossoms
Art Glass



2½" Colonial Style MasterFit Trim
painted Snow Mist White

MASTERFIT™ TRIM

Add the finishing touch to the interior of your window with the MasterFit trim system, complete with assembled frame extensions that interlock with mortise and tenon casing. The MasterFit trim system guarantees a precise, custom-fit and long-lasting factory applied finish.

See the *Special Order Casing Guide* for more casing profile options. For available paint and stain color options, see page 12.

Profiles

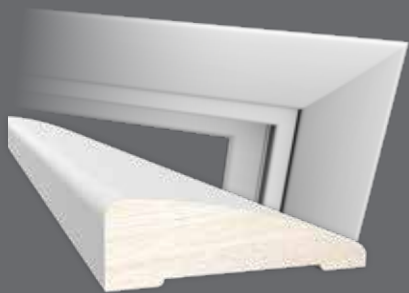

2 1/2" Modern Profile



2 1/2" Colonial Profile

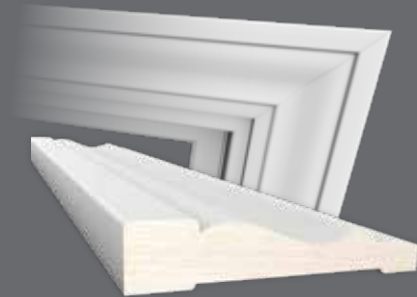

3 1/2" Colonial Profile

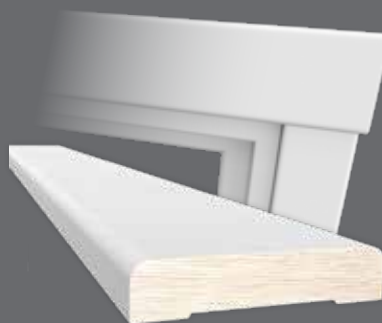

3 1/2" Flat

Mitered casing with high quality mortise and tenon corner locking system ensures strength and durability.



Additional Trim Options



Traditional Interior Stop
1 3/8" W x 1/2" H



Jamb Extension
2 1/2", 4 1/2", or 5 1/2" W x 3/4" H



Stool
4" or 6" W x 1" H



Shoemold Interior Stop
3/4" W x 1/2" H



Rosette
3/8"

WARRANTY HIGHLIGHTS



BASIC WINDOW OR PATIO DOOR UNIT - LIFETIME TRANSFERABLE

The rigid vinyl and factory-applied wood components of the window or patio door (not including factory installed jamb extensions), are warranted against chipping, cracking, peeling, pitting, blistering, warping or delamination for as long as you own and live in the Home in which the product was originally installed. This warranty is transferable to one subsequent purchaser.



HARDWARE - LIFETIME

ProVia® further warrants the moving parts, such as balances on double-hung windows and locking mechanisms in all units, for as long as the original purchaser owns and lives in the Home in which the product was originally installed, if those parts are not free from defects in material and workmanship under conditions of normal use and wear.



PATIO DOOR HANDLES - LIFETIME / 1 YEAR

ProVia further warrants all patio door handles with a Bright Brass, Satin Nickel or Aged Bronze finish against tarnishing for as long as you own and live in the Home in which the product was installed. Patio door handles with a painted finish, Flat Bronze, Modern Bronze or Antique Brass finish are warranted against flaking, checking, blistering or peeling for a period of (1) year from date of installation.



INSULATED GLASS UTILIZING SUPER SPACER® - LIFETIME

ProVia further warrants the insulated glass units utilizing Super Spacer in its vinyl windows or patio doors against defects resulting in material obstruction of vision as the result of film formation between the interior glass surfaces caused by failure of the air-tight seal, for as long as the original purchaser owns and lives in the Home in which the product was originally installed. Small spots, marks, lint, and scratches not exceeding applicable glass manufacturing specifications imposed by Federal Specification 1036-90 will not constitute defects under this warranty.

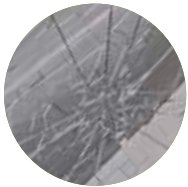

GLASS BREAKAGE - LIFETIME

ProVia further warrants the insulated glass units utilizing Super Spacer in its vinyl windows or patio doors against breakage as follows: (1) If the glass in a properly registered and warranty covered unit breaks as the result of a manufacturing defect; (2) In the event of an accident in the Home that is not covered by insurance or is of an amount that is within the insurance policy deductible, ProVia will replace the glass free of charge, for as long as the original purchaser owns and lives in the Home in which it was originally installed. Glass breakage is not covered for insulated glass units with internal blinds or insulated glass units in Garden Windows.



SCREENS - LIFETIME

Further, ProVia will replace under normal conditions of use, for as long as the original purchaser owns and lives in the Home in which the product was originally installed; for manufacturing defects, if the fiberglass, aluminum or stainless steel screening is not free from rotting, staining, or rusting. No warranty herein covers torn screen mesh caused by abnormal use, negligence, or other means not controlled by ProVia.



FLEXSCREENS - LIFETIME

Further, ProVia will replace under normal conditions of use, for as long as the original purchaser owns and lives in the Home in which the product was originally installed; for manufacturing defects, if the fiberglass screening is not free from rotting, staining, or rusting. No warranty herein covers torn screen mesh caused by abnormal use, negligence, or other means not controlled by ProVia.

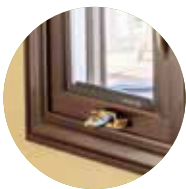

PAINT/STAIN FINISH - 15 YEAR / 10 YEAR

ProVia further warrants the factory-applied paint on exterior vinyl window components against cracking, pitting, peeling, blistering or suffering from non-uniform fading discoloration (non-uniform fading discoloration resulting from unequal exposure of surfaces to the sun and elements is not covered by this warranty) and defects in material and workmanship for a period of fifteen (15) years from date of installation.

ProVia further warrants the factory-applied paint or stain finish on interior wood components against flaking, checking, blistering or peeling and defects in material and workmanship for a period of ten (10) years from date of installation. Damage to the paint or stain finish caused by condensation and normal wear are not covered.



INTERNAL BLINDS - 10 YEAR

Internal blind units are warranted against seal failure and defects in material and workmanship for a period of ten (10) years from date of installation.



BAY, BOW & GARDEN WINDOWS - 10 YEAR

Bay and Bow windows (frames and roof kits) and Garden Windows (frames, sashes, hardware and insulated glass units) are warranted against defects in material and workmanship for a period of ten (10) years from date of installation. Garden windows are not available in the Aeris series.



TRANSFERABLE WARRANTY

The Warranty on the basic window or patio door unit is transferable by the original purchaser to one subsequent purchaser for purchaser’s personal residence provided the warranty transfer is completed within thirty (30) days after the date of transfer of ownership. Warranty transfers must be completed online at www.provia.com/warranty.



NON-RESIDENTIAL & MULTI-FAMILY APPLICATIONS

Where the structure in which the product is installed is not a single family residence occupied by the purchaser, or is owned by a public or private corporation for profit or non-profit, an unincorporated association or other business entity of any type recognized by law, a church, a school, a governmental or public authority, the time periods stated in this warranty shall be limited as follows: Basic Window or Patio Door Unit – 5 Year (non-transferable); Hardware - 1 Year; Insulated Glass – 10 Year (glass breakage not included); Internal Blinds – 5 Year; Screens – 5 Year; and Finishes – 1 Year.



COASTAL APPLICATIONS

For products that are installed in a Coastal region the time periods stated in this warranty shall be limited as follows: Non stainless steel hardware mechanisms in Casement Window & Patio Door units - 5 year mechanical warranty; Aged Bronze, Bright Brass or Satin Nickel Patio Door Handles – 10 Year Finish. Definition of Coastal Regions: For information and maps of Coastal regions please go to www.provia.com/coastalwarranty.



DISCOVER MORE

WEBSITE

ProVia.com makes it easy to explore and compare numerous door, window, siding, stone or roofing options in a straightforward, interactive way. Configure a door or window, visualize products on your home, explore color palettes, and learn about different architectural styles—all from our innovative Design Center. Save your favorite products, colors, photos or ideas throughout the site into your own ProVia® portfolio for reference any time and share them across your favorite social media platforms. ▶



VISUALIZER

Let your imagination run free with this exterior home design tool. Select from a library of existing home styles or upload a photo of your own home.

In a few easy steps, update your siding color, add stone or metal roofing, configure windows, or create a one-of-a-kind entry door system.

Looking for professionally inspired color and product palettes? Apply one of our pre-selected Designer Collections to create a curb-appealing look. ▽



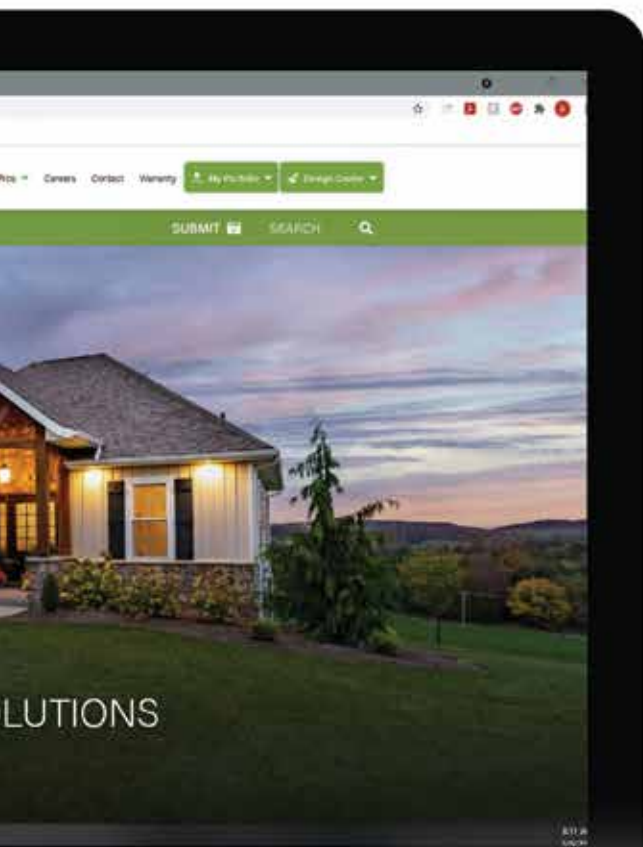

APP

Use the ProVia app to configure doors and windows or select from an extensive collection of vinyl siding, manufactured stone and metal roofing styles.

FEATURES

- Door and Window Configuration
- Vinyl Siding Profiles, Colors and Accessory Accents
- Manufactured Stone Styles, Color Palettes and Grout Options
- Metal Roofing Profiles, Trims and Colors
- Videos, Photo Galleries and Catalogs
- ProVia Dealer Locator



SOCIAL MEDIA

We love seeing how you apply our products to your home. Please share your photos with us.

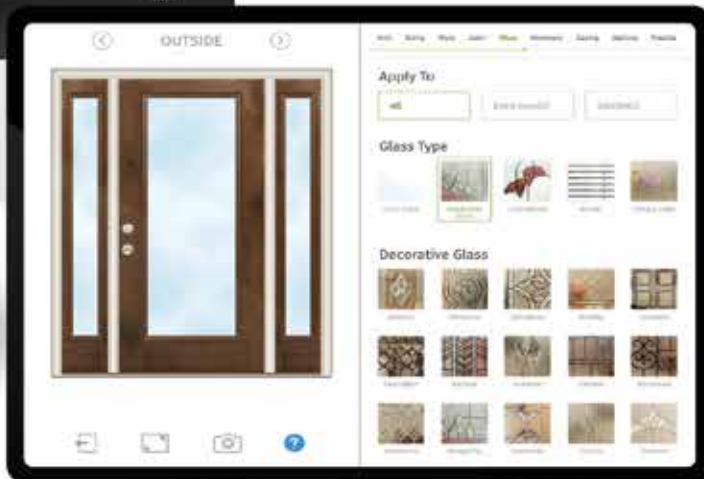



“To serve, by caring for details in ways others won’t.” It’s not just our mission, but a way of letting our light shine every day at ProVia®. We continually strive to put these words into action by providing unmatched quality and service. The P-icon symbolizes each employee’s commitment to devoting the utmost care, pride and quality into each building product we manufacture...it’s The Professional Way.



At ProVia, we manufacture energy efficient products and exercise corporate environmental stewardship by recycling, reducing pollution emissions and much more. In fact, our company has received repeated awards from the Environmental Protection Agency such as Partner of the Year - Sustained Excellence for outstanding efforts in energy savings.



DOORS | WINDOWS
SIDING | STONE | ROOFING
provia.com

© 2023 ProVia
P-MK-02500-23 | 4/23

Distributed by: